

REVISIONS	DESCRIPTION	APPROVED	DATE

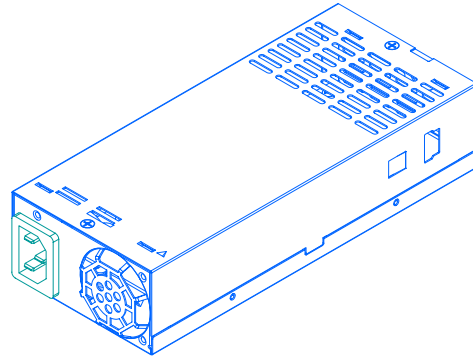

POWER WIRE LENGTH						
P1	P2	P3	P4	P5	P6	P7
300	300	300	200	300	150	150

NOTE:線材外露長度公差為±10mm.

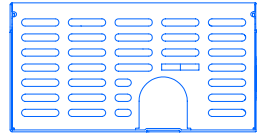
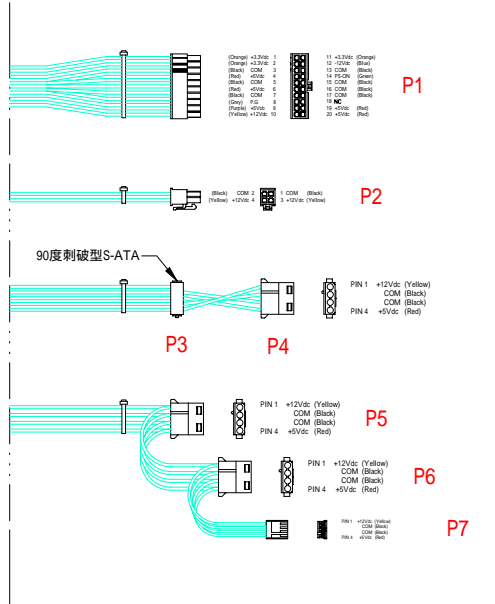
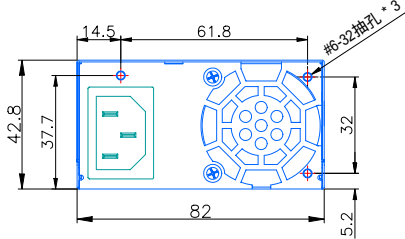
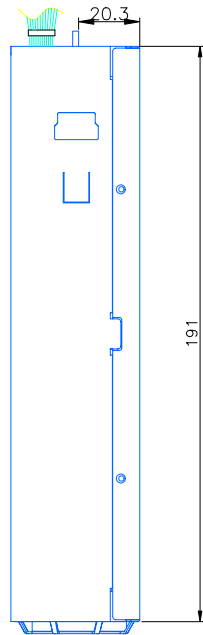
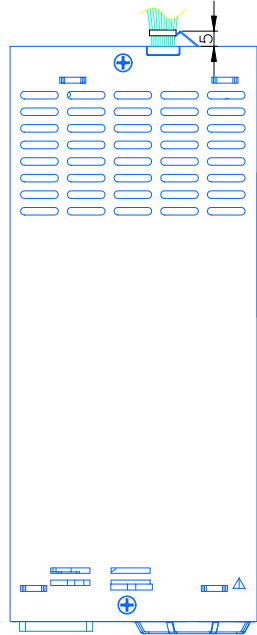
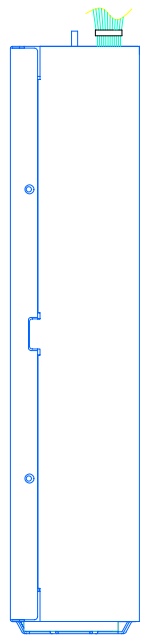

MODEL NAME	ST-220FAB示意图				
PART NO.		七盟電子工業股份有限公司			
MATERIAL	鍍鋅鋼板 T=0.6mm	DATE	2004/05/29		
APPROVED		PROJECTION			
CHECKED		REV NO.	A0	SCALE	1:1
DRAWN	吳成果	TOLERANCE	/	UNIT	mm